

Edition 11

31268280100 Waschtischunterbau

**PRODUKT**



**ZEICHNUNG**

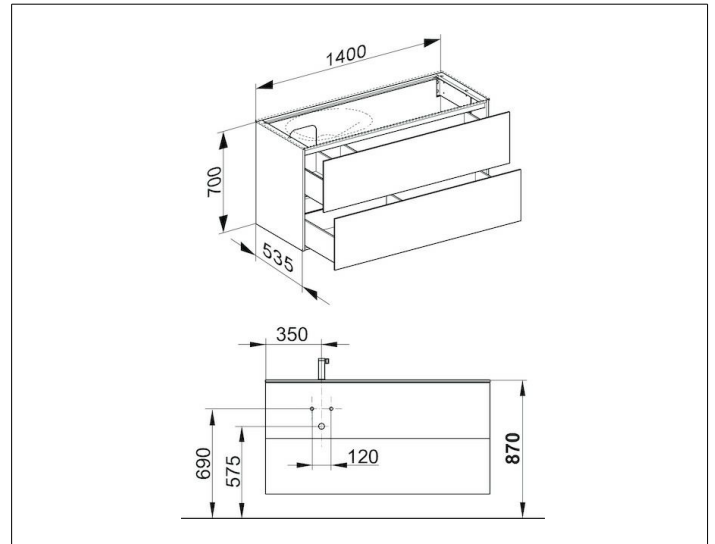

EEK: F ,

**OBERFLÄCHE**

cashmere/Glas cashmere satiniert

**ABMESSUNG**

1400 x 700 x 535 mm