



Einfach. Sicher.



## LEISTUNGSERKLÄRUNG

DoP: 0158

für Upat Hochleistungs-Verbundanker UHB-I (Verbundanker für die Verwendung in Beton) – DE

1. Eindeutiger Kenncode des Produkttyps: **DoP: 0158**
2. Verwendungszweck(e): **Nachträgliche Befestigung im gerissenen und ungerissenen Beton, siehe Anhang, insbesondere Anhänge B 1 bis B 7**
3. Hersteller: **Upat Vertriebs GmbH, Bebelstraße 11, 79108 Freiburg im Breisgau, Deutschland**
4. Bevollmächtigter: --
5. System(e) zur Bewertung und Überprüfung der Leistungsbeständigkeit: **1**
6. Europäisches Bewertungsdokument: **EAD 330499-00-0601**  
Europäische Technische Bewertung: **ETA-18/0864; 2018-12-12**  
Technische Bewertungsstelle: **DIBt**  
Notifizierte Stelle(n): **1343 – MPA Darmstadt**
7. Erklärte Leistung(en):

### **Mechanische Festigkeit und Standsicherheit (BWR 1)**

- **Charakteristische Zugtragfähigkeit (statische und quasi-statische Einwirkungen): Siehe Anhang, insbesondere Anhänge C 1 und C 2**
- **Charakteristische Quertragfähigkeit (statische und quasi-statische Einwirkungen): Siehe Anhang, insbesondere Anhänge C 3 und C 4**
- **Verschiebungen (statische und quasi-statische Einwirkungen): Siehe Anhang, insbesondere Anhänge C 5 und C 6**
- **Charakteristischer Widerstand und Verschiebungen für seismische Leistungskategorien C1 und C2: KLF**

### **Hygiene, Gesundheit und Umweltschutz (BWR 3)**

- **Inhalt, Emission und/oder Freisetzung von gefährlichen Stoffen: KLF**

8. Angemessene Technische Dokumentation und/oder Spezifische Technische Dokumentation: ---

Die Leistung des vorstehenden Produkts entspricht der erklärten Leistung/den erklärten Leistungen. Für die Erstellung der Leistungserklärung im Einklang mit der Verordnung (EU) Nr. 305/2011 ist allein der obengenannte Hersteller verantwortlich.

Unterzeichnet für den Hersteller und im Namen des Herstellers von:

Andreas Bucher, Dipl.-Ing.

Wolfgang Hengesbach, Dipl.-Ing., Dipl.-Wirtsch.-Ing.

Tumlingen, 2018-12-19

- Diese Leistungserklärung wurde in verschiedenen Sprachversionen erstellt. Für den Fall unterschiedlicher Auslegung hat immer die englische Version Vorrang.
- Der Anhang enthält freiwillige und ergänzende Informationen in englischer Sprache. Diese gehen über die (sprachneutral angegebenen) gesetzlichen Anforderungen hinaus.

**Specific Part**

**1 Technical description of the product**

The Upat High-performance-Bonded-Anchor UHB is a torque controlled bonded anchor consisting of a mortar cartridge with mortar UPM 66 and an anchor rod UHB – I – A L or UHB - I – A S with hexagon nut and washer.

The anchor rod is placed into a drilled hole filled with injection mortar. The load transfer is realised by mechanical interlock of several cones in the bonding mortar and then via a combination of bonding and friction forces in the anchorage ground (concrete).

The product description is given in Annex A.

**2 Specification of the intended use in accordance with the applicable European Assessment Document**

The performances given in Section 3 are only valid if the anchor is used in compliance with the specifications and conditions given in Annex B.

The verifications and assessment methods on which this European Technical Assessment is based lead to the assumption of a working life of the anchor of at least 50 years. The indications given on the working life cannot be interpreted as a guarantee given by the producer, but are to be regarded only as a means for choosing the right products in relation to the expected economically reasonable working life of the works.

**3 Performance of the product and references to the methods used for its assessment**

**3.1 Mechanical resistance and stability (BWR 1)**

Essential characteristic	Performance
Characteristic resistance to tension load (static and quasi-static loading)	See Annex C 1 and C 2
Characteristic resistance to shear load (static and quasi-static loading)	See Annex C 3 and C 4
Displacements (static and quasi-static loading)	See Annex C 5 and C 6
Characteristic resistance and displacements for seismic performance categories C1 and C2	No performance assessed

**3.2 Hygiene, health and the environment (BWR 3)**

Essential characteristic	Performance
Content, emission and/or release of dangerous substances	No performance assessed

**4 Assessment and verification of constancy of performance (AVCP) system applied, with reference to its legal base**

In accordance with the European Assessment Document EAD 330499-00-0601 the applicable European legal act is: [96/582/EC].

The system to be applied is: 1

Installation conditions part 1

**Upat High-performance-Bonded-Anchor UHB - I - A L**

**Pre-positioned installation**

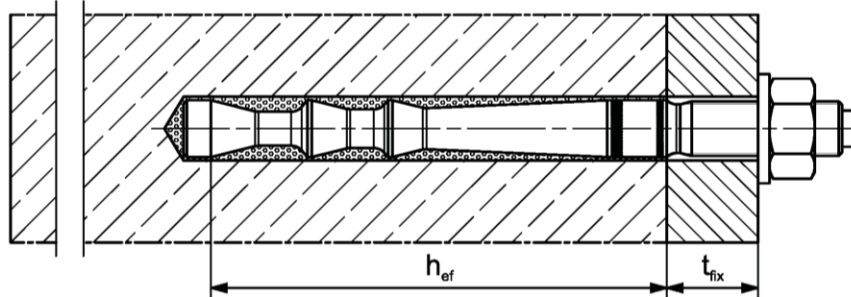

**Push through installation (annular gap filled with mortar)**

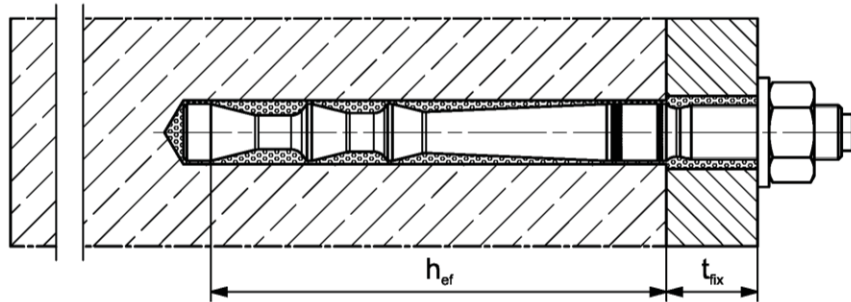

**Pre-positioned or push through installation with subsequently pressed filling disk (annular gap filled with mortar)**

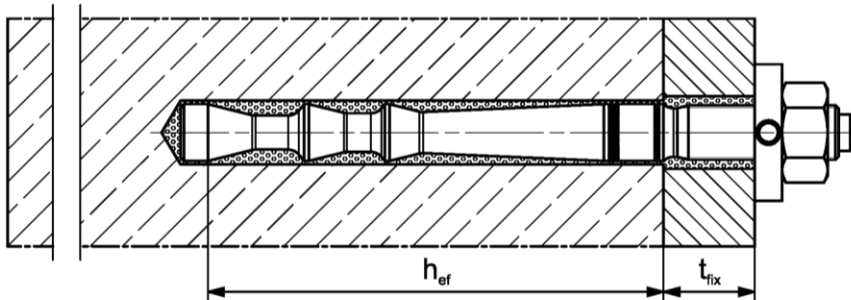

Pictures not to scale

$h_{ef}$  = effective anchorage depth

$t_{fix}$  = thickness of fixture

Upat High-performance-Bonded-Anchor UHB-I

**Product description**  
Installation conditions part 1; UHB - I - A L

**Annex A 1**

**Installation conditions part 2**

**Upat High-performance-Bonded-Anchor UHB - I - A S**

**Pre-positioned installation**

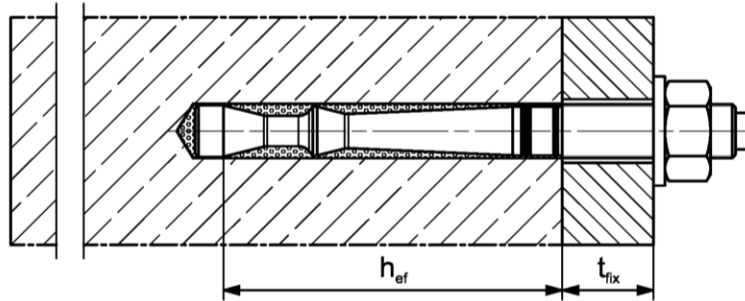

**Push through installation**

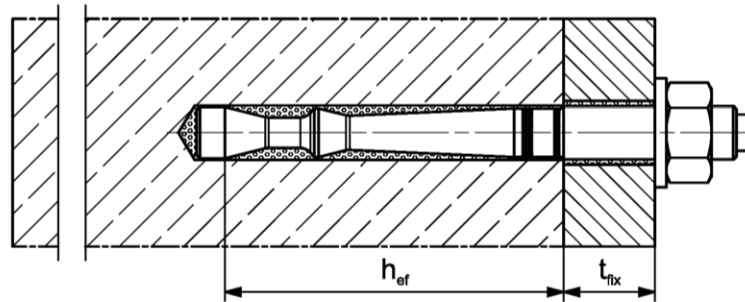

**Pre-positioned or push through installation with subsequently pressed filling disk (annular gap filled with mortar)**

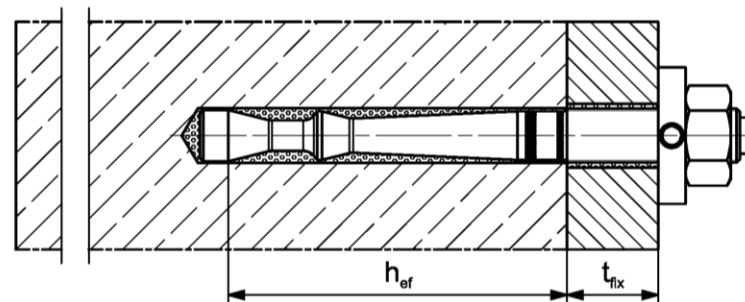

Pictures not to scale

$h_{ef}$  = effective anchorage depth

$t_{fix}$  = thickness of fixture

Upat High-performance-Bonded-Anchor UHB-I

**Product description**  
Installation conditions part 2; UHB - I - A S

**Annex A 2**

**Overview system components part 1**

**Mortar cartridge (shuttle cartridge) with sealing cap; Size: 360 ml**

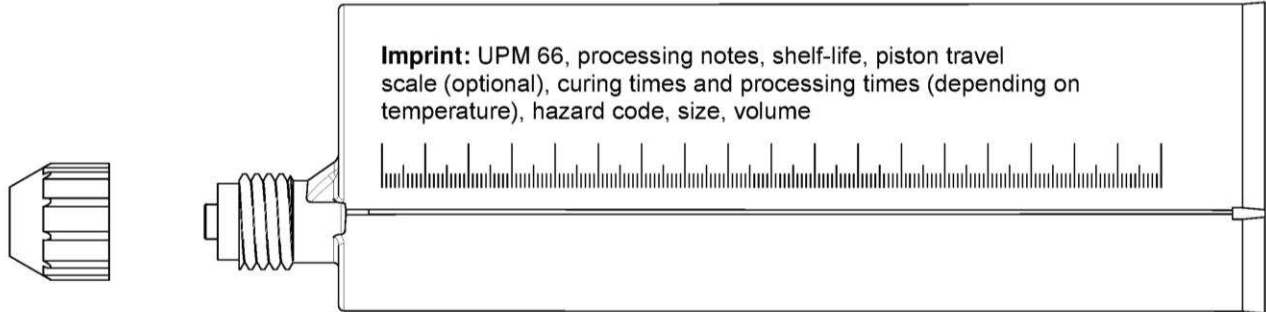

**Mortar cartridge (coaxial cartridge) with sealing cap; Size: 150 ml, 300 ml**

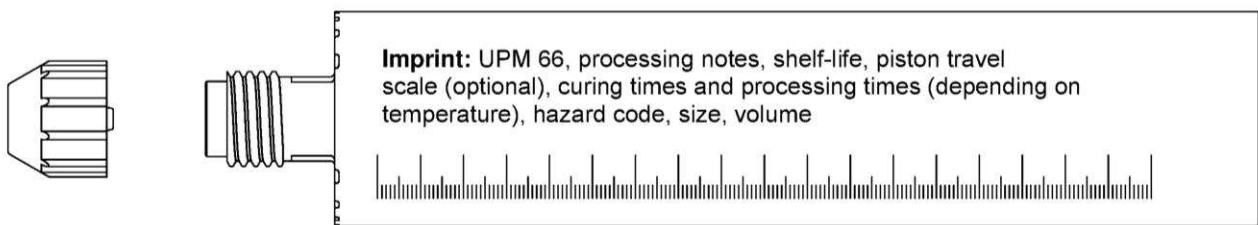

**Static mixer Upat MR Plus**

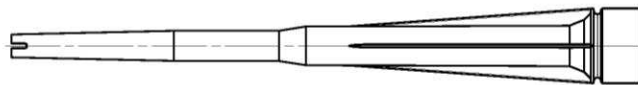

**Extension tube for static mixer**



**Cleaning brush BS**



**Blow-out pump**





Pictures not to scale



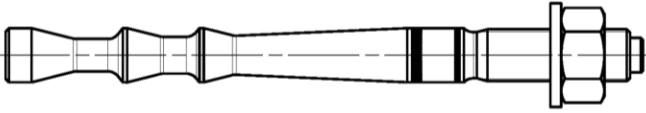
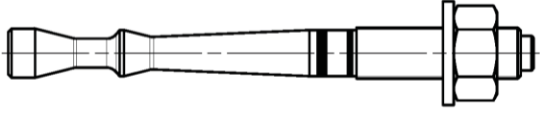
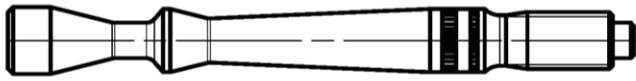
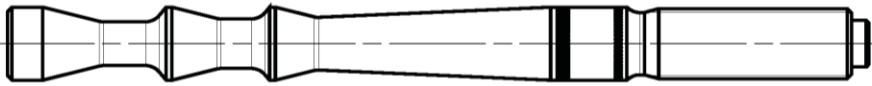
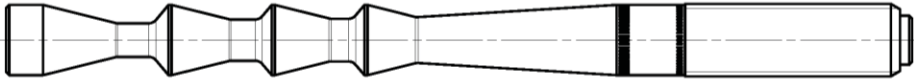
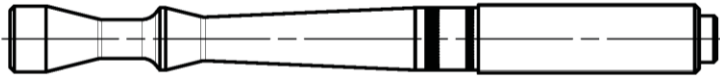

**Upat High-performance-Bonded-Anchor UHB-I**

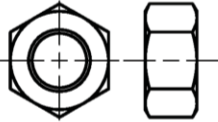
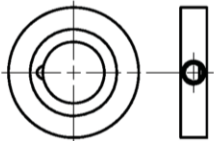
**System description**  
Overview system components part 1;  
cartridges / accessories

**Annex A 3**

<b>Overview system components part 2</b>	
<b>Upat High-performance-Anchor rod; pre-assembled condition</b>	
<b>Upat High-performance-Anchor rod UHB - I - A L</b>	<b>Upat High-performance-Anchor rod UHB - I - A S</b>
	
<b>Anchor rod UHB - I - A L</b> Size: M8	
	
<b>Anchor rod UHB - I - A L</b> Size: M10, M12, M16	
	
<b>Anchor rod UHB - I - A L</b> Size: M20, M24	
	
<b>Anchor rod UHB - I - A S</b> Size: M10, M12, M16, M20, M24	
	
<b>Washer</b>	
<b>Hexagon nut</b>	
<b>Filling disk</b>	
Pictures not to scale	
<b>Upat High-performance-Bonded-Anchor UHB-I</b>	<b>Annex A 4</b>
<b>System description</b> Overview system components part 2; Anchor rod / washer / hexagon nut / filling disk	

<b>Table A5.1: Materials</b>				
<b>Part</b>	<b>Designation</b>	<b>Material</b>		
1	Mortar cartridge	Mortar, hardener, filler		
	Steel grade	Steel, zinc plated	Stainless steel A4	High corrosion resistant steel C
2	Upat High-performance-Anchor rod UHB - I - A L or UHB - I - A S	Property class 8.8; EN ISO 898-1:2013 zinc plated $\geq 5 \mu\text{m}$ , EN ISO 4042:1999 A2K $f_{uk} \leq 1000 \text{ N/mm}^2$ $A_5 > 12 \%$ fracture elongation	Property class 80 EN ISO 3506-1:2009 1.4401; 1.4404; 1.4578; 1.4571; 1.4439; 1.4362; 1.4062, 1.4662, 1.4462 EN 10088-1:2014 $f_{uk} \leq 1000 \text{ N/mm}^2$ $A_5 > 12 \%$ fracture elongation	Property class 80 EN ISO 3506-1:2009 1.4565; 1.4529 EN 10088-1:2014 $f_{uk} \leq 1000 \text{ N/mm}^2$ $A_5 > 12 \%$ fracture elongation
3	Washer ISO 7089:2000	zinc plated $\geq 5 \mu\text{m}$ , EN ISO 4042:1999 A2K	1.4401; 1.4404; 1.4578; 1.4571; 1.4439; 1.4362; EN 10088-1:2014	1.4565;1.4529 EN 10088-1:2014
4	Hexagon nut	Property class 8; EN ISO 898-2:2012 zinc plated $\geq 5 \mu\text{m}$ , ISO 4042:1999 A2K	Property class 70 EN ISO 3506-1:2009 1.4401; 1.4404; 1.4578; 1.4571; 1.4439; 1.4362; EN 10088-1:2014	Property class 70 EN ISO 3506-1:2009 1.4565; 1.4529 EN 10088-1:2014
5	Filling disk similar to DIN 6319-G	zinc plated $\geq 5 \mu\text{m}$ , EN ISO 4042:1999 A2K	1.4401; 1.4404; 1.4578; 1.4571; 1.4439; 1.4362; EN 10088-1:2014	1.4565;1.4529 EN 10088-1:2014
Upat High-performance-Bonded-Anchor UHB-I				<b>Annex A 5</b>
System description Materials				

<b>Specifications of intended use (part 1)</b>					
<b>Table B1.1: Overview use and performance categories</b>					
Anchorages subject to		UPM 66 with ...			
		UHB - I - A L		UHB - I - A S	
					
Hammer drilling with standard drill bit		all sizes			
Hammer drilling with hollow drill bit (fischer "FHD", Heller "Duster Expert", Bosch "Speed-Clean" or Hilti "TE-CD, TE-YD")		Nominal drill bit diameter ( $d_0$ ) $\geq$ 12 mm			
Static or quasi static load, in	cracked concrete	all sizes	Tables: C1.1, C3.1, C5.1	all sizes	Tables: C2.1, C4.1, C6.1
	uncracked concrete				
Use category	dry or wet concrete	all sizes			
Kind of installation	Pre-positioned anchor	all sizes			
	Push through anchor	all sizes			
Installation temperature		0°C to +40°C			
In-service temperature		-40°C to +80°C (max. short term temperature +80 °C and max. long term temperature +50 °C)			
Upat High-performance-Bonded-Anchor UHB-I					<b>Annex B 1</b>
Intended use Specifications (part 1)					



**Specifications of intended use (part 2)**

**Base materials:**

- Compacted reinforced or unreinforced normal weight concrete without fibres of Strength classes C20/25 to C50/60 according to EN 206:2013

**Use conditions (Environmental conditions):**

- Structures subject to dry internal conditions  
(zinc coated steel, stainless steel or high corrosion resistant steel)
- Structures subject to external atmospheric exposure (including industrial and marine environment) and to permanently damp internal condition, if no particular aggressive conditions exist  
(stainless steel or high corrosion resistant steel)
- Structures subject to external atmospheric exposure, to permanently damp internal conditions or in other particular aggressive conditions (high corrosion resistant steel)

Note: Particular aggressive conditions are e.g. permanent, alternating immersion in seawater or the splash zone of seawater, chloride atmosphere of indoor swimming pools or atmosphere with extreme chemical pollution (e.g. in desulphurization plants or road tunnels where de-icing materials are used)

**Design:**

- Anchorages have to be designed by a responsible engineer with experience of concrete anchor design
- Verifiable calculation notes and drawings are to be prepared taking account of the loads to be anchored. The position of the anchor is indicated on the design drawings (e.g. position of the anchor relative to reinforcement or to supports, etc.)
- Anchorages are designed in accordance with EN 1992-4:2018 and EOTA Technical Report TR055

**Installation:**

- Anchor installation is to be carried out by appropriately qualified personnel and under the supervision of the person responsible for technical matters of the site
- In case of aborted hole: The hole shall be filled with mortar
- Observe the effective anchorage depth
- Overhead installation is allowed

Upat High-performance-Bonded-Anchor UHB-I	<b>Annex B 2</b>
<b>Intended Use</b> Specifications (part 2)	

**Table B3.1:** Installation parameters for Upat High-performance-Bonded-Anchor rods UHB - I - A L

Anchor rod UHB - I - A L		Thread	M8x		M10x		M12x		M16x			M20x	M24x
			60	95	100	120	125	145	160	210	210		
Cone diameter	$d_k$	[mm]	9,4	10,7	12,5		16,8			23,0			
Width across flats	SW		13	17	19		24			30	36		
Nominal drill hole diameter	$d_0$		10	12	14		18			25			
Drill hole depth	$h_0$		66	101	106	126	131	151	166	216			
Effective anchorage depth	$h_{ef}$		60	95	100	120	125	145	160	210			
Minimum spacing and minimum edge distance	$s_{min} = c_{min}$		40		50		55	60	70	90			
Diameter of clearance hole in the fixture	pre-positioned anchorage $d_f \leq$		9	12	14		18			22	26		
	push through anchorage $d_f \leq$		11	14	16		20			26			
Min. thickness of concrete member	$h_{min}$		100	140		170		190	220	280			
Installation torque	$T_{inst}$ [Nm]		15	20	40		60			100			
Thickness of fixture	$t_{fix} \leq$	1500											
Filling disk <sup>1)</sup>	$\geq d_a$	-	26	30		38			46	54			
	$t_s$	-	6	6		7			8	10			

<sup>1)</sup> Using filling disk reduces  $t_{fix}$  (usable length of the anchor)

**Upat High-performance-Bonded-Anchor rod UHB - I - A L**

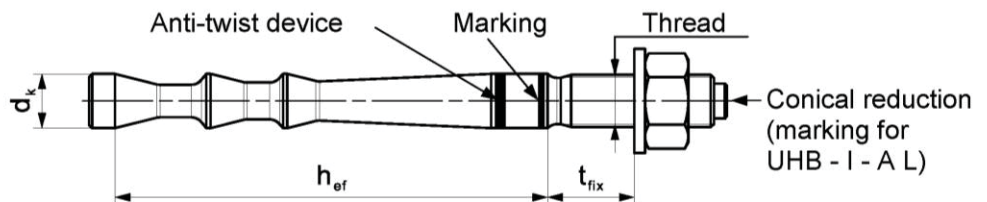

**Marking:** work symbol, size of anchor, setting depth. e.g.: UHB-I M10x95  
 For stainless steel additional **A4**. For high corrosion resistant steel additional **C**.  
 For high corrosion resistant steel additional marking **C** also on the face side

**Installation conditions :**

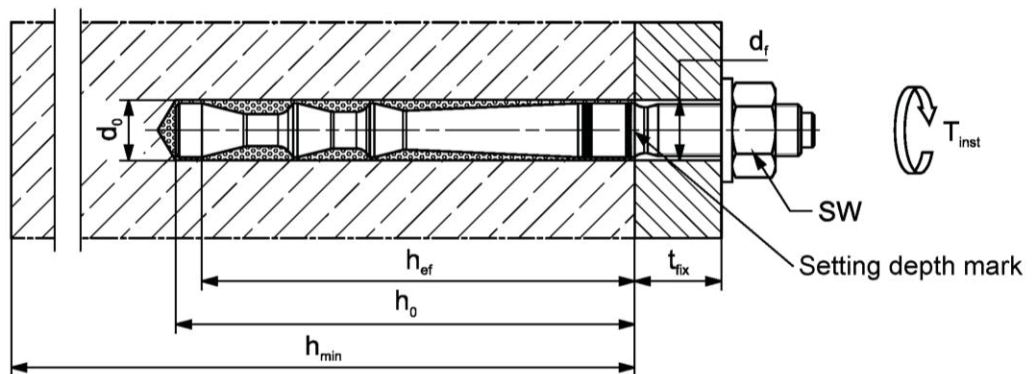

Pictures not to scale

Upat High-performance-Bonded-Anchor UHB-I

**Intended Use**  
 Installation parameters Upat High-performance-Bonded-Anchor rod UHB - I - A L

**Annex B 3**

**Table B4.1:** Installation parameters for Upat High-performance-Bonded-Anchor rods UHB - I - A S

Anchor rod UHB - I - A S	Thread	M10x		M12x	M16x	M20x	M24x
		60	75	75	95	170	170
Cone diameter	$d_k$	9,4		11,3	14,5	23,0	
Width across flats	SW	17		19	24	30	36
Nominal drill hole diameter	$d_0$	10		12	16	25	
Drill hole depth	$h_0$	66	81	81	101	176	
Effective anchorage depth	$h_{ef}$	60	75	75	95	170	
Minimum spacing and minimum edge distance	$s_{min} = C_{min}$	40			50	80	
Diameter of clearance hole in the fixture	pre-positioned anchorage	$d_f \leq 12$		14	18	22	26
	push through anchorage	$d_f \leq 12$		14	18	26	
Min. thickness of concrete member	$h_{min}$	100	120		150	240	
Installation torque	$T_{inst}$	15		30	50	100	
Thickness of fixture	$t_{fix} \leq$	1500					
filling disk <sup>1)</sup>	$\geq d_a$	26		30	38	46	54
	$t_s$	6		6	7	8	10

<sup>1)</sup> Using filling disk reduces  $t_{fix}$  (usable length of the anchor)

**Upat High-performance-Bonded-Anchor rod UHB - I - A S**

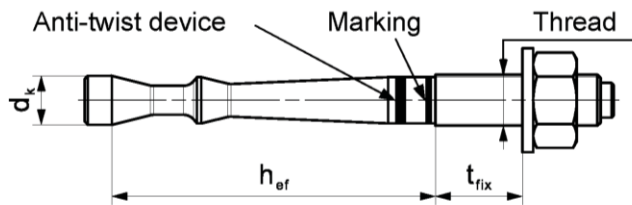

**Marking:** work symbol, size of anchor, setting depth. e.g.: UHB-I M10x75  
 For stainless steel additional **A4**. For high corrosion resistant steel additional **C**.  
 For high corrosion resistant steel additional marking **C** also on the face side

**Installation conditions:**

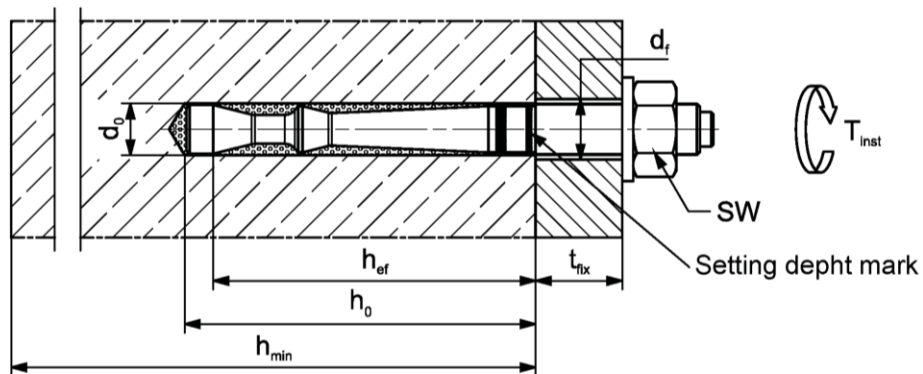

Pictures not to scale

Upat High-performance-Bonded-Anchor UHB-I

**Intended Use**

Installation parameters Upat High-performance-Bonded-Anchor rod UHB - I - A S

**Annex B 4**

**Table B5.1:** Parameters of the cleaning brush BS (steel brush)

The size of the steel brush refers to the nominal drill hole diameter

Drill hole diameter	$d_0$	[mm]	10	12	14	16	18	25
Brush diameter	$d_b$		11	13	16	20		27

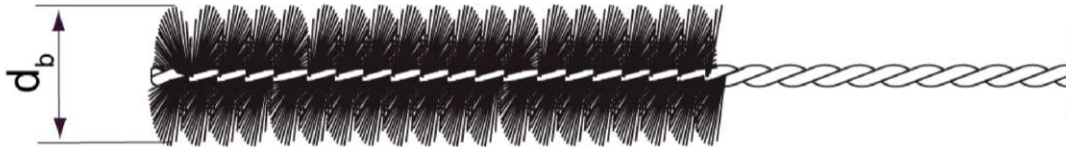

**Table B5.2:** Maximum processing time of the mortar **UPM 66** and minimum curing time (During the curing time of the mortar the concrete temperature may not fall below the listed minimum temperature)

Concrete temperature [°C]	Maximum processing time $t_{work}$	Minimum curing time <sup>1)</sup> $t_{cure}$
0 to +4	---	3 h
> +5 to +9	15 min	90 min
> +10 to +19	6 min	35 min
> +20 to +29	4 min	20 min
> +30 to +40	2 min	12 min

<sup>1)</sup> In wet concrete the curing times must be doubled











Pictures not to scale



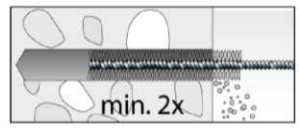

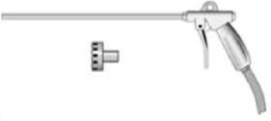

Upat High-performance-Bonded-Anchor UHB-I

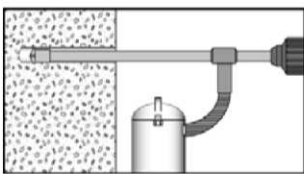
**Intended Use**

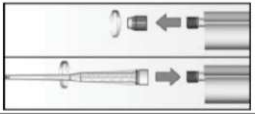
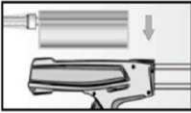
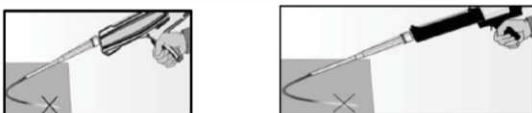
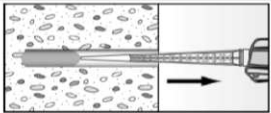
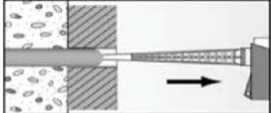
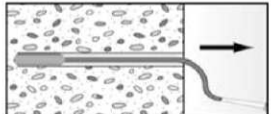
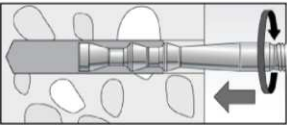
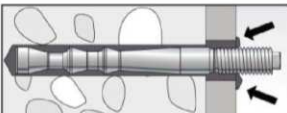
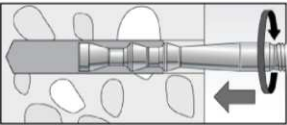
Parameters of the cleaning brush; Processing times and curing times

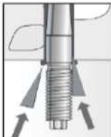
**Annex B 5**

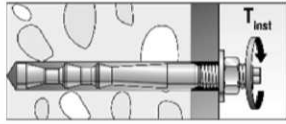
<b>Installation instructions part 1; Installation with UPM 66</b>	
<b>Drilling and cleaning the hole (hammer drilling with standard drill bit)</b>	
<b>1</b>	 <p>Drill the hole with hammer drill. Drill hole diameter <math>d_0</math> and drill hole depth <math>h_0</math> see <b>Tables B3.1, B4.1</b></p>
<b>2</b>	 <p>Blow out the drill hole twice. If necessary, remove standing water out of the bore hole</p>
	 <p>For drill hole diameter <math>d_0 &lt; 25</math> mm with hand-blowout or oil-free compressed air</p>
	 <p>For drill hole diameter <math>d_0 = 25</math> mm with oil-free compressed air (&gt; 6 bar) Use a cleaning nozzle.</p>
<b>3</b>	 <p>Brush the bore hole twice. Corresponding brushes see <b>Table B5.1</b></p>
	
<b>4</b>	 <p>Blow out the drill hole twice</p>
	 <p>For drill hole diameter <math>d_0 &lt; 25</math> mm with hand-blowout or oil-free compressed air</p>
	 <p>For drill hole diameter <math>d_0 = 25</math> mm with oil-free compressed air (&gt; 6 bar) Use a cleaning nozzle.</p>
Go to step 5	
<b>Drilling and cleaning the hole (hammer drilling with hollow drill bit)</b>	
<b>1</b>	 <p>Check a suitable hollow drill (see <b>Table B1.1</b>) for correct operation of the dust extraction</p>
<b>2</b>	 <p>Use a suitable dust extraction system, e. g. Bosch GAS 35 M AFC or a comparable dust extraction system with equivalent performance data Drill the hole with hollow drill bit. The dust extraction system has to extract the drill dust nonstop during the drilling process and must be adjusted to maximum power. Diameter of drill hole <math>d_0</math> and drill hole depth <math>h_0</math> see <b>Tables B3.1, B4.1</b></p>
Go to step 5	
Upat High-performance-Bonded-Anchor UHB-I	
<b>Intended use</b> Installation instructions part 1; Installation with injection mortar	
<b>Annex B 6</b>	

<b>Installation instructions part 2; Installation with UPM 66</b>			
<b>Preparing the cartridge</b>			
5		Remove the sealing cap Screw on the static mixer (the spiral in the static mixer must be clearly visible)	
6			Place the cartridge into the dispenser
7			Extrude approximately 10 cm of material until the resin is evenly grey in colour. Do not use mortar that is not uniformly grey
<b>Injection of the mortar</b>			
8		Fill approximately 2/3 of the drill hole with mortar. Exact quantity of mortar (travel scale on the cartridge) see instruction sheet. Fill the drill hole with mortar, always begin from the bottom of the hole to avoid bubbles	
		<b>Push-through installation:</b> By using High-performance-Bonded-Anchor rods <b>UHB - I - AL</b> the drill hole in the fixture must be also filled with mortar. By using High-performance-Bonded-Anchor rods <b>UHB - I - AS</b> is this not necessary.	
		For drill hole depth $\geq 170$ mm use an extension tube	
<b>Installation High-performance-Bonded-Anchor rods UHB - I - A L and UHB - I - A S</b>			
9		Only use clean and oil-free anchor rods. Push the anchor rod down to the bottom of the hole, turning it slightly while doing so.	
10		After inserting the anchor rod <b>UHB - I - AL</b> , surplus mortar must be escaped from the fixture. After inserting the anchor rod <b>UHB - I - AS</b> , surplus mortar must be escaped from the bore hole or must be visible in the fixture.	
		For overhead installations support the anchor rod with wedges. (e.g. Upat centering wedges)	
11		Wait for the specified curing time $t_{cure}$ see <b>Table B5.2</b>	
		12	
			Mounting the fixture $T_{inst}$ see <b>Tables B3.1, B4.1</b>
Option		After the minimum curing time is reached, the gap between anchor and fixture (annular clearance) may be filled with mortar via the filling disc. Compressive strength $\geq 50$ N/mm <sup>2</sup> (e.g. UPM 66). ATTENTION: Using filling disk reduces $t_{fix}$ (usable length of the anchor)	
Upat High-performance-Bonded-Anchor UHB-I			<b>Annex B 7</b>
Intended use Installation instructions part 2; Installation with injection mortar			

<b>Table C1.1: Essential characteristics under static and quasi-static tension load for Upat High-performance-Bonded-Anchors UHB - I - A L</b>											
Anchor rod UHB - I - A L			M8x 60	M10x 95	M12x 100   120		M16x 125   145   160			M20x 210	M24x 210
<b>Bearing capacity under tensile load, steel failure</b>											
Characteristic resistance $N_{Rk,s}$	Steel, zinc plated	[kN]	25,1	34,4	49,8		96,6			137,6	
	Stainless steel A4										
	High corrosion resistant steel C		25,1	34,4	49,8		96,6			137,6	
<b>Partial factors<sup>1)</sup></b>											
Partial factor $\gamma_{Ms,N}$	Steel, zinc plated	[-]	1,5 <sup>1)</sup>								
	Stainless steel A4		1,5 <sup>1)</sup>								
	High corrosion resistant steel C		1,5 <sup>1)</sup>								
<b>Pullout failure in cracked concrete C20/25</b>											
Characteristic resistance	$N_{Rk,p}$	[kN]	--- <sup>2)</sup>								
<b>Pullout and splitting failure in uncracked concrete C20/25</b>											
Characteristic resistance	$N_{Rk,p}$	[kN]	--- <sup>2)</sup>								
Spacing	$s_{cr,sp}$	[mm]	300	476	380	600	375	500	580	630	
Edge distance	$c_{cr,sp}$		150	238	190	300	188	250	290	315	
<b>Pullout and splitting failure in uncracked concrete C20/25</b>											
Characteristic resistance	$N_{Rk,p}$	[kN]	20	35	40	50	--- <sup>2)</sup>	75	95	--- <sup>2)</sup>	
Spacing	$s_{cr,sp}$	[mm]	3,0 $h_{ef}$								
Edge distance	$c_{cr,sp}$		1,5 $h_{ef}$								
<b>Factors for the compressive strength of concrete &gt; C20/25</b>											
Increasing factor for $N_{Rk,p}$	C25/30	$\Psi_c$	[-]	1,10							
	C30/37			1,22							
	C35/45			1,34							
	C40/50			1,41							
	C45/55			1,48							
	C50/60			1,55							
<b>Factors for concrete cone failure</b>											
Cracked concrete	$k_{cr,N}$	[-]	7,7								
Uncracked concrete	$k_{ucr,N}$		11,0								
<b>Concrete cone failure</b>											
Effective anchorage depth	$h_{ef}$	[mm]	60	95	100	120	125	145	160	210	
Partial factor <sup>1) 3)</sup>	$\gamma_{Mc}$	[-]	1,8								
<sup>1)</sup> In absence of other national regulations. <sup>2)</sup> Not decisive <sup>3)</sup> $\gamma_{inst} = 1,2$ is included.											
Upat High-performance-Bonded-Anchor UHB-I										<b>Annex C 1</b>	
<b>Performance</b> Essential characteristics under static and quasi-static tension load for Upat High-performance-Bonded-Anchors UHB - I - A L											

<b>Table C2.1: Essential characteristics under static and quasi-static tension load for Upat High-performance-Bonded-Anchors UHB - I - A S</b>							
Anchor rod UHB - I - A S		M10x		M12x	M16x	M20x	M24x
		60	75	75	95	170	170
<b>Bearing capacity under tensile load, steel failure</b>							
Characteristic resistance $N_{Rk,s}$	Steel, zinc plated	[kN]	25,1	34,4	61,6	128,5	
	Stainless steel A4		25,1	34,4	61,6	128,5	
	High corrosion resistant steel C						
<b>Partial factors<sup>1)</sup></b>							
Partial factor $\gamma_{Ms,N}$	Steel, zinc plated	[-]	1,5 <sup>1)</sup>				
	Stainless steel A4		1,5 <sup>1)</sup>				
	High corrosion resistant steel C		1,5 <sup>1)</sup>				
<b>Pullout failure in cracked concrete C20/25</b>							
Characteristic resistance	$N_{Rk,p}$	[kN]	--- <sup>2)</sup>				
<b>Pullout and splitting failure in uncracked concrete C20/25</b>							
Characteristic resistance	$N_{Rk,p}$	[kN]	--- <sup>2)</sup>				
Spacing	$s_{cr,sp}$	[mm]	300	340	510		
Edge distance	$c_{cr,sp}$		150	170	255		
<b>Pullout and splitting failure in uncracked concrete C20/25</b>							
Characteristic resistance	$N_{Rk,p}$	[kN]	20	25	40	--- <sup>2)</sup>	
Spacing	$s_{cr,sp}$	[mm]	3,0h <sub>ef</sub>				
Edge distance	$c_{cr,sp}$		1,5h <sub>ef</sub>				
<b>Factors for the compressive strength of concrete &gt; C20/25</b>							
Increasing factor for $N_{Rk,p}$	C25/30	$\Psi_c$	[-]	1,10			
	C30/37			1,22			
	C35/45			1,34			
	C40/50			1,41			
	C45/55			1,48			
	C50/60			1,55			
<b>Factors for concrete cone failure</b>							
Cracked concrete	$k_{cr,N}$	[-]	7,7				
Uncracked concrete	$k_{ucr,N}$		11,0				
<b>Concrete cone failure</b>							
Effective anchorage depth	$h_{ef}$	[mm]	60	75	95	170	
Partial factor <sup>1) 3)</sup>	$\gamma_{Mc}$	[-]	1,8				
<sup>1)</sup> In absence of other national regulations. <sup>2)</sup> Not decisive <sup>3)</sup> $\gamma_{inst} = 1,2$ is included.							
Upat High-performance-Bonded-Anchor UHB-I						<b>Annex C 2</b>	
<b>Performance</b> Essential characteristics under static and quasi-static tension load for Upat High-performance-Bonded-Anchors UHB - I - A S							



<b>Table C3.1: Essential characteristics under static and quasi-static shear load for Upat High-performance-Bonded-Anchors UHB - I - A L</b>										
Anchor rod UHB - I - A L			M8x 60	M10x 95	M12x 100   120		M16x 125   145   160		M20x 210	M24x 210
<b>Bearing capacity under shear load, steel failure</b>										
<b>without lever arm</b>										
Characteristic resistance	Steel, zinc plated	$V_{Rk,s}^0$ [kN]	13,7	20,8	30,3		56,3		87,9	126,9
	Stainless steel A4 and High corrosion resistant steel C		15,2	23,2	33,7		62,7		97,9	141
<b>with lever arm</b>										
Characteristic bending moment	Steel, zinc plated	$M_{Rk,s}^0$ [Nm]	31	62	105		266		519	896
	Stainless steel A4 and High corrosion resistant steel C		31	62	105		266		519	896
<b>Partial factors</b>										
Partial factor <sup>1)</sup>		$\gamma_{Ms,V}$	[-]		1,25					
Ductility factor		$k_7$	[-]		1,0					
<b>Concrete pry-out failure</b>										
Factor		$k_8$	[-]		2,0					
Partial factor <sup>1)</sup>		$\gamma_{Mcp}$	[-]		1,5					
<b>Concrete edge failure</b>										
Effective length of anchor	$l_f$	[mm]	60	95	100	112	125	144		200
Calculation diameter	$d$		10	12	14		18		25	
Partial factor <sup>1)</sup>		$\gamma_{Mc}$	[-]		1,5					
<sup>1)</sup> In absence of other national regulations.										
Upat High-performance-Bonded-Anchor UHB-I									<b>Annex C 3</b>	
<b>Performance</b> Essential characteristics under static and quasi-static shear load for Upat High-performance-Bonded-Anchors UHB - I - A L										

<b>Table C4.1: Essential characteristics under static and quasi-static shear load for Upat High-performance-Bonded-Anchors UHB - I - A S</b>								
Anchor rod UHB - I - A S		M10x		M12x	M16x	M20x	M24x	
		60	75	75	95	170	170	
<b>Bearing capacity under shear load, steel failure</b>								
<b>without lever arm</b>								
Characteristic resistance	Steel, zinc plated	$V_{Rk,s}^0$	[kN]	19,7	27,3	50,8	80,3	114,2
	Stainless steel A4			24,1	33,7	62,7	97,9	124,5
	High corrosion resistant steel C			24,1	33,7	62,7	97,9	141
<b>with lever arm</b>								
Characteristic bending moment	Steel, zinc plated	$M_{Rk,s}^0$	[Nm]	62	105	266	519	896
	Stainless steel A4 and High corrosion resistant steel C			62	105	266	519	896
<b>Partial factors</b>								
Partial factor <sup>1)</sup>	$\gamma_{Ms,V}$	[-]	1,25					
Ductility factor	$k_7$	[-]	1,0					
<b>Concrete pry-out failure</b>								
Factor	$k_8$	[-]	2,0					
Partial factor <sup>1)</sup>	$\gamma_{Mcp}$	[-]	1,5					
<b>Concrete edge failure</b>								
Effective length of anchor	$l_f$	[mm]	60	75	95	170		
Calculation diameter	$d$		10	12	16	25		
Partial factor <sup>1)</sup>	$\gamma_{Mc}$	[-]	1,5					
<sup>1)</sup> In absence of other national regulations.								
Upat High-performance-Bonded-Anchor UHB-I						<b>Annex C 4</b>		
<b>Performance</b> Essential characteristics under static and quasi-static shear load for Upat High-performance-Bonded-Anchors UHB - I - A S								

<b>Table C5.1: Displacement for Upat High-performance-Bonded-Anchor UHB - I - A L</b>									
<b>Anchor rod UHB - I - A L</b>	<b>M8x 60</b>	<b>M10x 95</b>	<b>M12x</b>		<b>M16x</b>			<b>M20x 210</b>	<b>M24x 210</b>
			<b>100</b>	<b>120</b>	<b>125</b>	<b>145</b>	<b>160</b>		
<b>Displacement under tension load</b>									
<b>Cracked concrete</b>									
Tension load [kN]	6,6	15,9	17,1	22,5	24,0	30,0	34,7	52,2	52,2
$\delta_{N0}$ [mm]	0,8				0,6				
$\delta_{N\infty}$	1,7								
<b>Uncracked concrete</b>									
Tension load [kN]	9,3	22,3	24,0	31,6	33,6	42,0	48,7	73,2	73,2
$\delta_{N0}$ [mm]	0,2	0,4						0,6	
$\delta_{N\infty}$	1,7								
<b>Displacement under shear load</b>									
<b>Uncracked or cracked concrete</b>									
<b>Steel zinc plated</b>									
Shear load [kN]	7,8	11,9	17,3		32,2			50,2	72,5
$\delta_{V0}$ [mm]	1,2		1,3				3,5		
$\delta_{V\infty}$	1,8		2,0				5,3		
<b>Stainless steel A4</b>									
Shear load [kN]	8,7	13,3	19,3		35,8			55,9	80,6
$\delta_{V0}$ [mm]	1,0		1,1		2,2			3,5	
$\delta_{V\infty}$	1,5		1,7		3,3			5,3	
<b>High corrosion resistant steel C</b>									
Shear load [kN]	8,7	13,3	19,3		35,8			55,9	80,6
$\delta_{V0}$ [mm]	1,2		1,3		2,4			3,7	5,0
$\delta_{V\infty}$	1,8		2,0		3,6			5,6	7,5
Upat High-performance-Bonded-Anchor UHB-I								<b>Annex C 5</b>	
<b>Performance</b> Displacement for Upat High-performance-Bonded-Anchor UHB - I - A L									

<b>Table C6.1: Displacement for Upat High-performance-Bonded-Anchor UHB - I - A S</b>						
<b>Anchor rod UHB - I - A S</b>	<b>M10x</b>		<b>M12x</b>	<b>M16x</b>	<b>M20x</b>	<b>M24x</b>
	<b>60</b>	<b>75</b>	<b>75</b>	<b>95</b>	<b>170</b>	<b>170</b>
<b>Displacement under tension load</b>						
<b>Cracked concrete</b>						
Tension load [kN]	6,6	11,1	15,9	38,0		
$\delta_{N0}$ [mm]	0,8	0,3	0,4	0,6		
$\delta_{N\infty}$	1,7					
<b>Uncracked concrete</b>						
Tension load [kN]	9,3	15,6	22,3	53,3		
$\delta_{N0}$ [mm]	0,2				0,5	
$\delta_{N\infty}$	1,7					
<b>Displacement under shear load</b>						
<b>Cracked or uncracked concrete</b>						
<b>Steel zinc plated</b>						
Shear load [kN]	11,3	12,7	29,0	45,9	65,3	
$\delta_{V0}$ [mm]	1,2	1,5	2,8			
$\delta_{V\infty}$	1,8	2,3	4,2			
<b>Stainless steel A4</b>						
Shear load [kN]	13,8	19,3	35,8	55,9	71,1	
$\delta_{V0}$ [mm]	1,0	1,1	2,2	3,5		
$\delta_{V\infty}$	1,5	1,7	3,3	5,3		
<b>High corrosion resistant steel C</b>						
Querlast [kN]	13,8	19,3	35,8	55,9	80,6	
$\delta_{V0}$ [mm]	1,2	1,3	2,4	3,7	5,0	
$\delta_{V\infty}$	1,8	2,0	3,6	5,6	7,5	
Upat High-performance-Bonded-Anchor UHB-I					<b>Annex C 6</b>	
<b>Performance</b> Displacement for Upat High-performance-Bonded-Anchor UHB - I - A S						